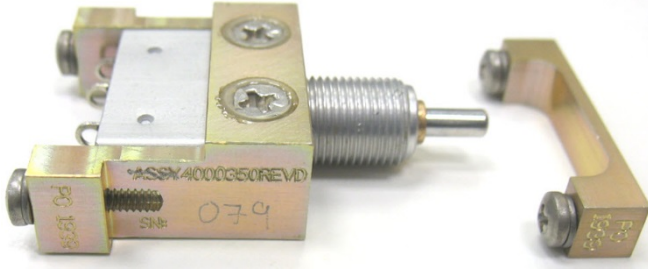
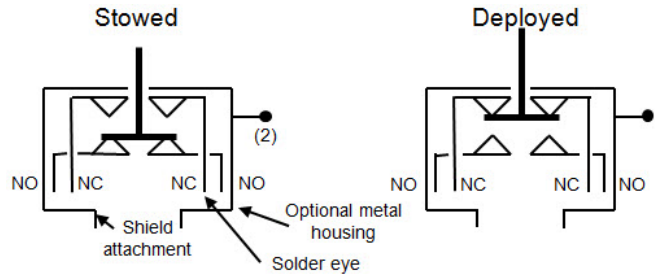

FEATURES and BENEFITS

- Significant spaceflight heritage (TRL 9)
- Sealed Sub-Miniature Snap Action
- Meets MIL-PRF-8805 enclosure design symbol 3
- Spaceflight qualified
- Gold Contacts
- Vibration resistant
- Compact and low mass

Figure 1: Lower Switch Bracket (left) and Upper Switch Bracket (right)

Figure 2: Schematic. Switch is SPDT-DB (Form Z)
CONTENTS

FEATURES.....	1
REVISION HISTORY	1
RATINGS.....	1
MECHANICAL INTERFACE.....	2
IDENTIFICATION AND MARKINGS	2
TYPICAL APPLICATION.....	3
SUSCEPTIBILITY TO INTERMITTENCY.....	3
RECOMMENDED PROCEDURE.....	3

REVISION HISTORY
Table 1: Revision History

Rev	Date	Design	Review	Notes
-	12Jul12	RW	WH	Initial Revision
A	22Jun15	AZ	RW	1) Removed EMI Switch Assembly option. 2) Removed revisions from "Source Document" Column of Table 2. 3) Clarified isolation parameter in Table 2.

RATINGS
Table 2: Ratings

Symbol	Parameter	Test Conditions	Min.	Typ.	Max.	Unit	Source Document
I _{ssv}	Current through each lug, steady state, vacuum	Pressure(P) <10 ⁻⁵ Torr, Temperature(T) = +110C and -40C, NC channel at I _{ssv} , NO and NC circuits simultaneously powered	-	-	5.0	A	2002029
I _{ssa}	Current through each lug, steady state, ambient	P=760 Torr, T= +23C NC channel at I _{ssa} , NO and NC circuits simultaneously powered	-	-	5.0	A	2002204
I _{pv}	Pulsed current through pin	P <10 ⁻⁵ Torr, T = -54C-130C, NC channel at I _{ssv} , duration < 10.0 seconds, NO and NC circuits simultaneously powered	-	-	5.0	A	2002309
R _{ms}	Mated switch resistance	P= 760 Torr, T= +23 C	-	0.005	0.0075	Ω	2002204
V _{iso}	Isolation, lug to lug, lug to switch bracket, or lug to switch housing	P= 760 Torr, T= +23 C	-	-	1,500	VDC	2002204
T _o	Operating temperature	P <10 ⁻⁵ Torr	-30	23	+100	C	2002029
T _s	Survival temperature	P <10 ⁻⁵ Torr	-30	-	+100	C	2002029
T _i	Soldering temperature	Duration less than 3.0 seconds	310	315.5	321	C	NASA-STD-8739.3
-	Wire Size		20	22	-	AWG	2002204
W _l	Weight of Lower Switch Bracket	No attachment fasteners	-	0.037	-	Lbs	2002204
W _u	Weight of Upper Switch Bracket	No attachment fasteners	-	0.004	-	Lbs	2002204
F _i	Initial separation force		-	3.71	-	Lbf	2000785
D _{scj}	Height at state change during joining		-	1.54	-	Inch	2002204
D _{ms}	Height of stowed switch		1.37	1.38	1.39	Inch	2002204
D _{scd}	Height at state change during deploying		-	1.58	-	Inch	2002204
D _{md}	Height at mechanical separation		1.58	1.59	1.60	Inch	2002204
P	Life		-	5,000	-	cycles	2001025

MECHANICAL INTERFACE

Electrically joined. Switch changes state.

Stowed

Electrically separated. Switch changes state.

Mechanically separated

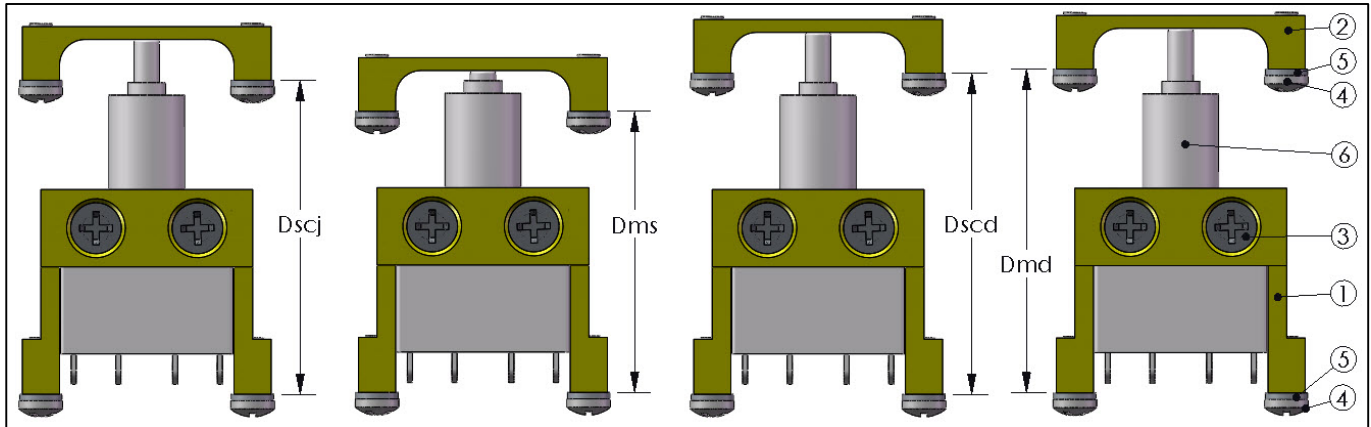
Figure 1: Mechanical interface
Table 3: Bill of Materials

Item	Number & Description	Material	Surface Finish	QTY
6	Switch	Refer to manufacturer	Refer to manufacturer	1
5	NAS620C4, 0.115 x 0.209 x 0.032 Washer	Stainless Steel	None	4
4	MS51957-14, 0.112-40 x 0.31 PNH Screw	Stainless Steel	None	4
3	MS24693-C27, 0.138-32 x 0.44 FLH Screw	Stainless Steel	None	2
2	4000351 Lower Switch Bracket	6061 Aluminum Alloy	Chemical Film per Mil-C-5541, Class 3, Color Gold	1
1	4000350 Upper Switch Bracket	6061 Aluminum Alloy	Chemical Film per Mil-C-5541, Class 3, Color Gold	1
			Surface Finish	

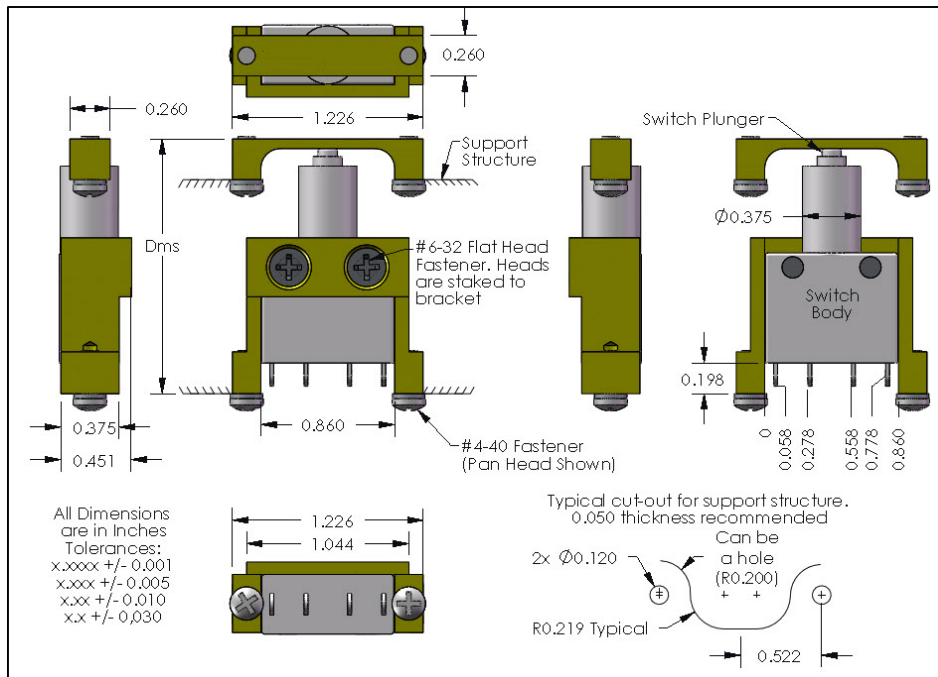
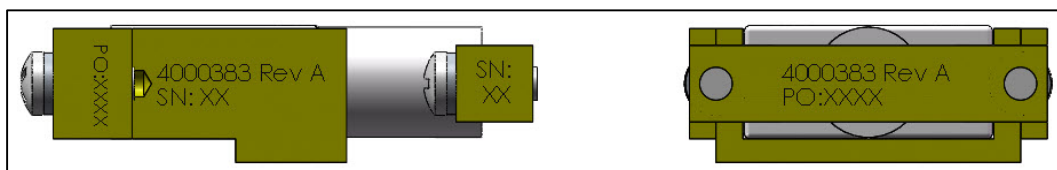
Figure 2: Dimensions
IDENTIFICATION AND MARKINGS

Figure 3: Identification and markings

TYPICAL APPLICATION

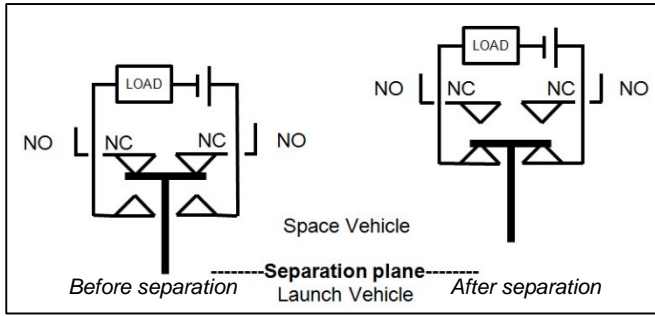

Figure 4: Separation Switches are typically used on space vehicle separation systems like Lightband.

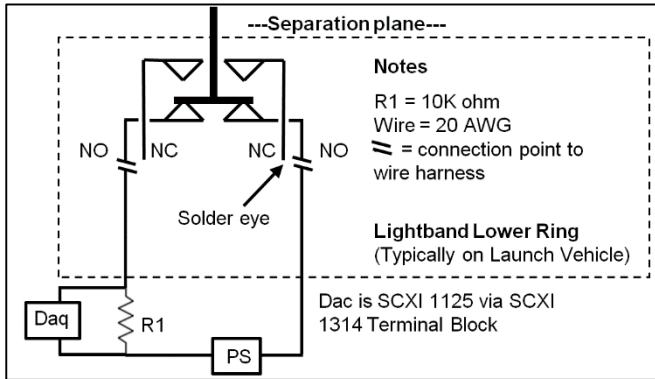

Figure 5: Circuit used to test for intermittencies during extreme vibration testing.

RECOMMENDED PROCEDURE

Notes:

- 1) Practice this process especially if access and/or volume is limited.
- 2) If installing on a Lightband the feature in the Upper and Lower Rings is not much larger than the switch opening. The shield termination described here is designed to take a minimum of space around the opening.
- 3) Once this procedure is completed the separation switch will be constrained to the other alignment features of the Lightband. Consequently the separation switch(es) always align properly when the Lightband is mated.
- 5) Separation switches may be added to Lightband before or after it has been stowed.
- 6) When attaching to structures other than Lightband this section may be used a guideline for proper installation.

Step 1 Tin the wire(s). Use Type RMA soldering flux and SN60PB40 solder. Set soldering iron temperature to 600 degrees F (315.5 C). Apply heat no longer than 3 seconds. Form the tinned wire into a J shape as shown.

SUSCEPTIBILITY TO INTERMITTENCY AT EXTREMES OF VIBRATION

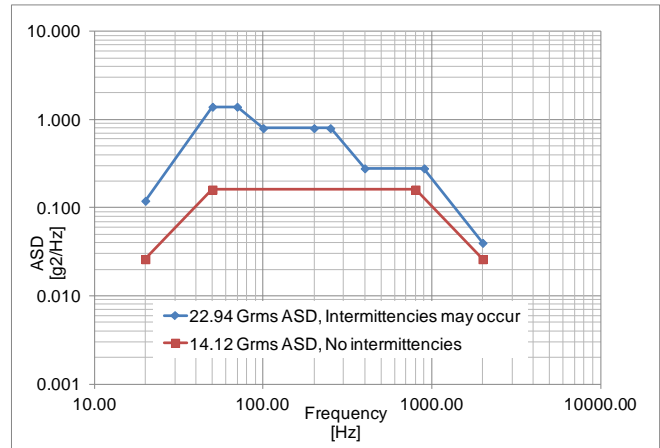

Figure 6: Intermittency and vibration

Test level [Grms]	Axis	Sample rate [Hz]	Comments
14.10	X,Y,Z	100000	No Intermittencies
14.1-22.94	X,Y,Z	N/A	Intermittencies may occur
22.94	X,Y,Z	10000	Intermittencies

At greater than 14.1 Grms intermittency may occur. After intermittency switch always returns to previous state. Use multiple switches or low pass filtering to reduce/eliminate intermittency if vibration exceeds 14.1 GRMS.

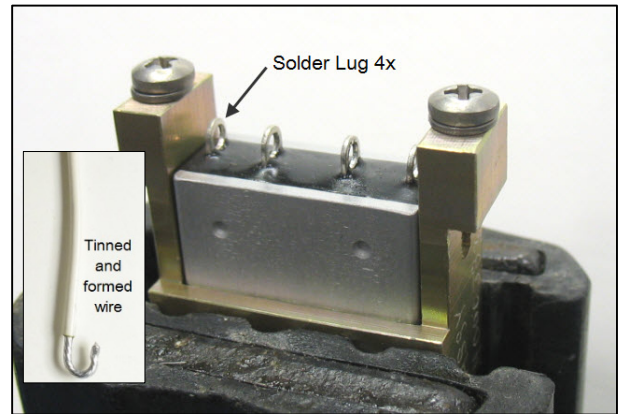

Figure 7: Tinning the hardware

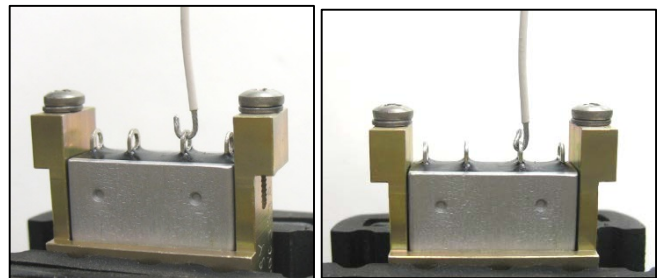

Figure 8: Installing the formed wire on the lug.

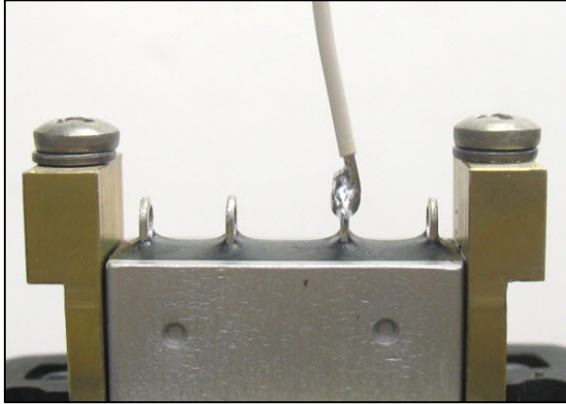

Figure 9: Typical solder fillet on installed wire (shown cleaned)

Step 2 Install wire on switch lug and form wire to lug. Solder wire to lug. Note: It may be helpful to pre-form some of the wires to allow them to properly exit the switch bracket.

Step 3 Clean the solder flux, with 99% pure Isopropanol alcohol. Do this several times. Removing all solder flux residue is essential.

Step 4 Add clear heat-shrink (Kynar 3/32-1/8 inch diameter) and apply heat to shrink. The heat will tend to evaporate any retained alcohol. You may want add potting to the connector. Use caution! Depending on viscosity potting may seep onto the switch plunger which could be detrimental to performance.

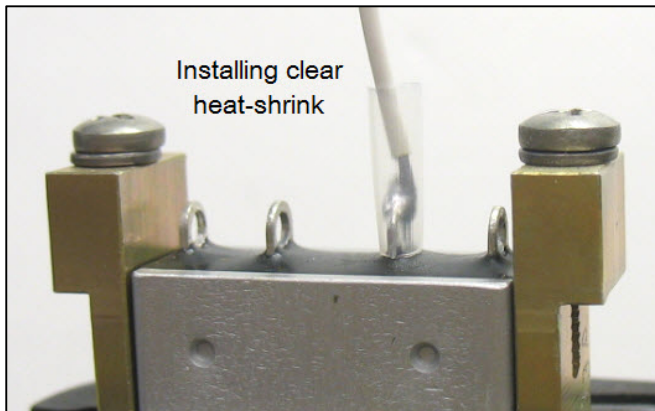

Figure 10: Heat shrink slipped over solder cup and ready for heat

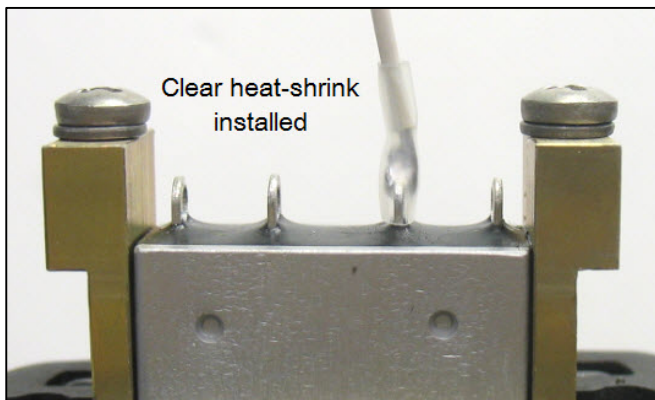

Figure 11: Heat shrink installed

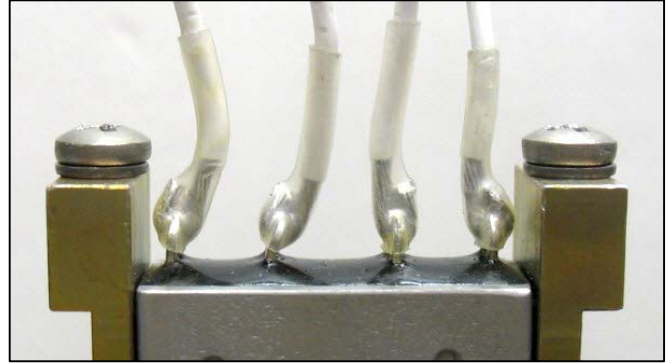

Figure 12: All wires installed with heat-shrink

Step 6 Wrap harness with tape to provide abrasion protection.

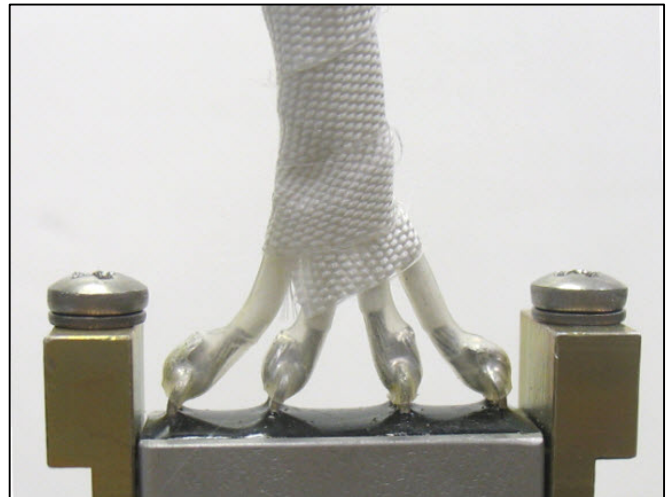

Figure 13: Taped wires exiting switch.

Step 7 If required, attach shielding. Use 0.020 inch CRES lock-wire. Several loops may be required. Trim excess. The shielding and lock-wires should not exceed the switch housing by more than 0.010 inches. Verify lock-wire is not degrading conductor insulation.

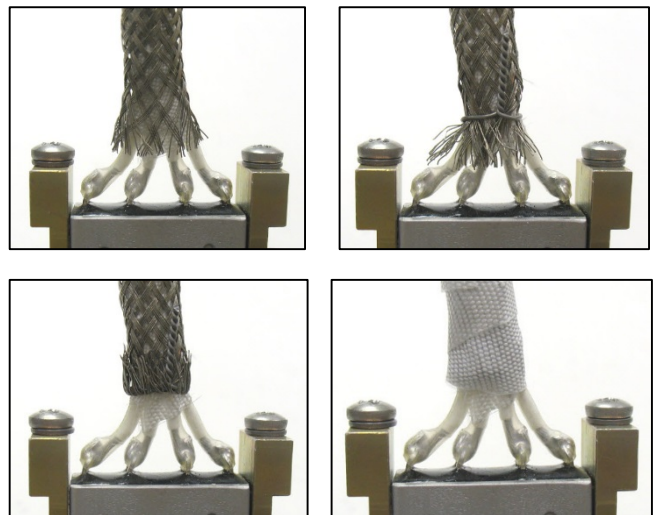

Figure 14: Shielding installation on switch.

Step 8 Form wires at switch bracket exit to avoid interference with adjoining structure when harness is fastened to adjoining structure.



Figure 15: A Complete harness.

Step 9 If installing on a stowed Lightband install the upper switch bracket first. Depending on application this bracket can be installed on the Lightband upper ring or Lightband lower ring. Torque the 4-40 fasteners to 3.0 +/- 1.0 inch lb. The accepting thread is no more than 0.35 inches deep. Compress the switch plunger on the lower switch bracket and slide it into the space above the upper switch bracket. Adjust the lower switch bracket until the accepting threads are aligned with the through holes on the Lightband. Torque the 4-40 fasteners to 3.0 +/- 1.0 inch lb. The accepting thread is no more than 0.35 inches deep.

Step 10 If installing on a deployed Lightband follow step 9 but omit compressing the spring plunger.



Figure 16: Lower switch bracket installed on upper ring. Upper switch bracket installed on lower ring. Harness is taped and formed.

Step 11 Fasten the harness to the adjoining structure. Ensure harness will not interfere with mating plane to adjoining structures.

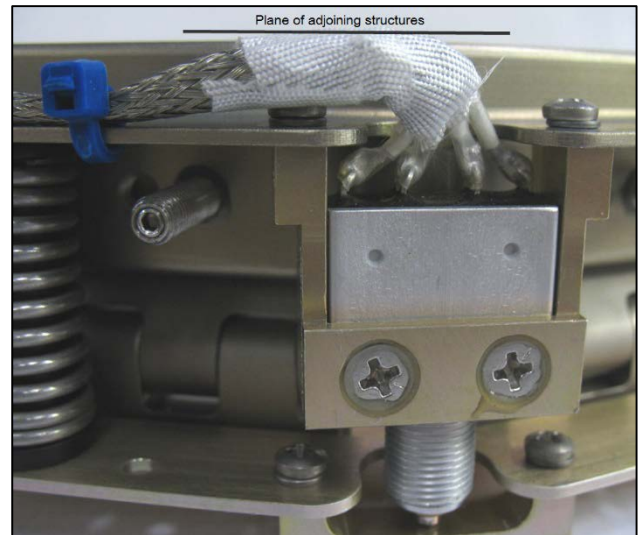

Figure 17: Example of Separation Switch installed on Lightband. Harness is constrained to adjoining structure with 4 inch Tefzel cable tie